

Laboratory Experiments Examining Ultrafine Particle Production by Re-breathing of Road Dust through a Diesel Engine

K.J. Bein, Y. Zhao, A.S. Wexler
University of California Davis

E. Lipsky and A.L. Robinson
Carnegie Mellon University

Hypothesis and Motivation

Re-breathing involves the uptake and internal processing of ambient road dust particles by vehicular engines. The effect of re-breathing will be to transfer road dust constituents from the coarse mode into the fine and ultrafine modes. This has serious implications since small transfers of coarse mode mass can produce large numbers of fine and ultrafine particles, significantly increasing the risk of respiratory health effects. An essential step in validating its existence is identifying the presence of road dust constituents in the fine and ultrafine particles of an engine's exhaust. These particles should contain mixtures of EC/OC and road dust elements. A series of experiments have been performed to examine the feasibility of re-breathing.

Experimental

I. Instrumentation

Yanmar L60AE Diesel Engine



Schematic of CMU Dilution Sampler

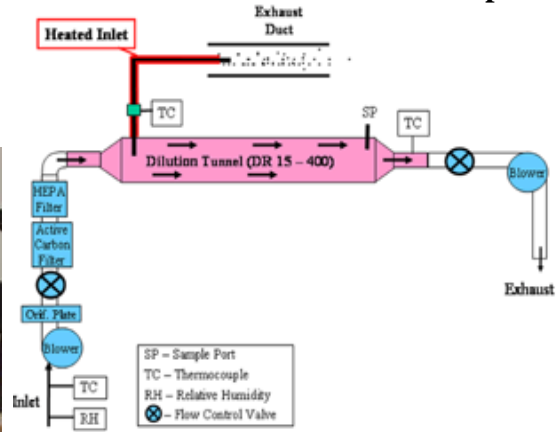

Single Particle Mass Spectrometer – RSMS-2

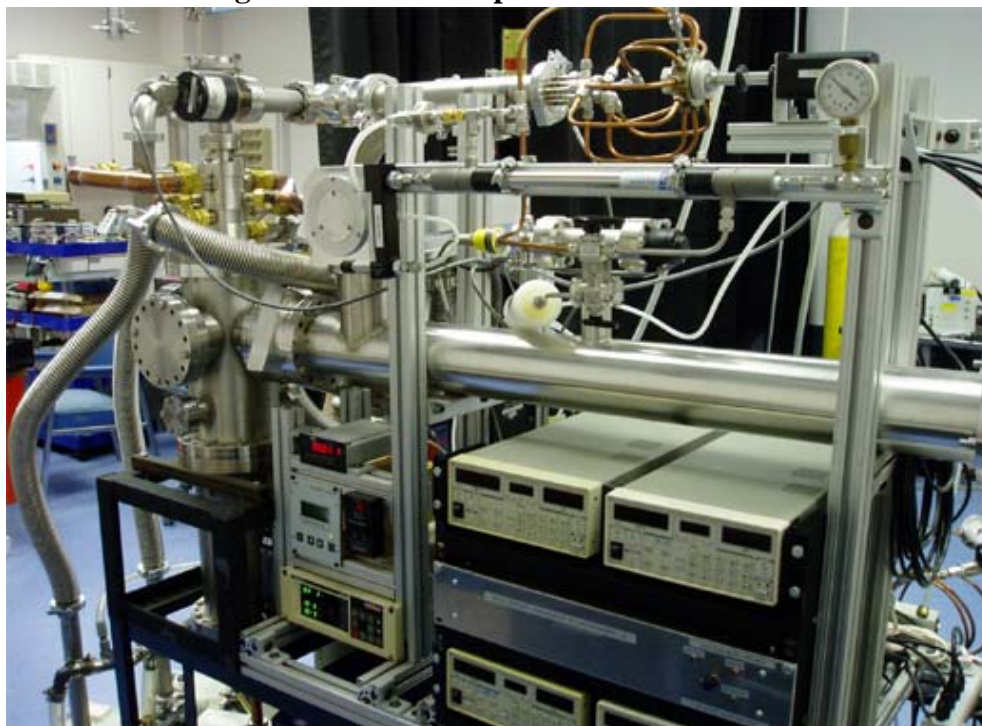

Additional

- i. MOUDI with subsequent chemical analysis by ICP-MS
- ii. SMPS - LDMA only
- iii. Teflon bag for re-suspending road dust samples

II. Sampling Procedure

i. Road Dust Sampling

- Road dust samples were collected from rural and urban sites.
- The road dust samples were then re-suspended in a Teflon bag and sampled and analyzed using RSMS-2, an SMPS and a MOUDI.

ii. Diesel Re-breath Sampling

- Yanmar's L60AE series diesel engine was operated under two conditions:
 1. The engines air intake drawn directly from a particle free Teflon bag (no air filter) and
 2. The air intake drawn directly from a Teflon bag containing re-suspended road dust (no air filter)
- Exhaust from the diesel engine was fed through CMU's dilution system and then sampled and analyzed using RSMS-2, an SMPS and a MOUDI.

Results pt. I - Road Dust In

I. Road Dust Mass Distributions

- Figures i and ii below show the distribution of road dust mass as measured by the SMPS, MOUDI and RSMS-2
- Notice the excellent quantitative agreement between the SMPS and MOUDI measurements.
- Also notice that the RSMS-2 data traces both the SMPS and MOUDI measurements extremely well.

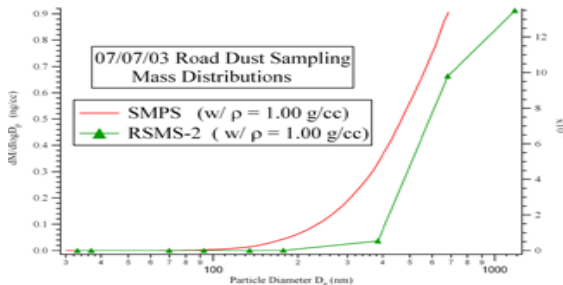

i.

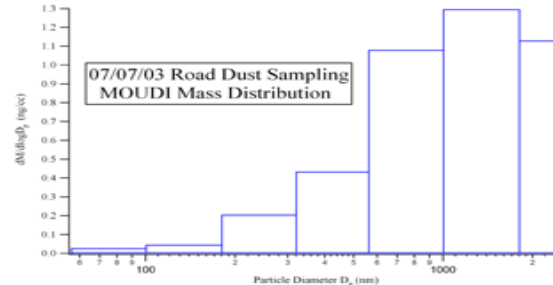

ii.

II. Road Dust Composition

- Figure i. below shows the volume distribution of the major particle classes identified by RSMS-2.

- Iron, calcium, aluminum, potassium and silicon were observed to be the largest contributors to road dust mass.

- Figure ii depicts mass distributions for the dominant metals detected during ICP-MS analysis of the MOUDI filters.

- This data shows that copper, iron, calcium, aluminum and potassium were observed to be the largest contributors (silicon was not measured).

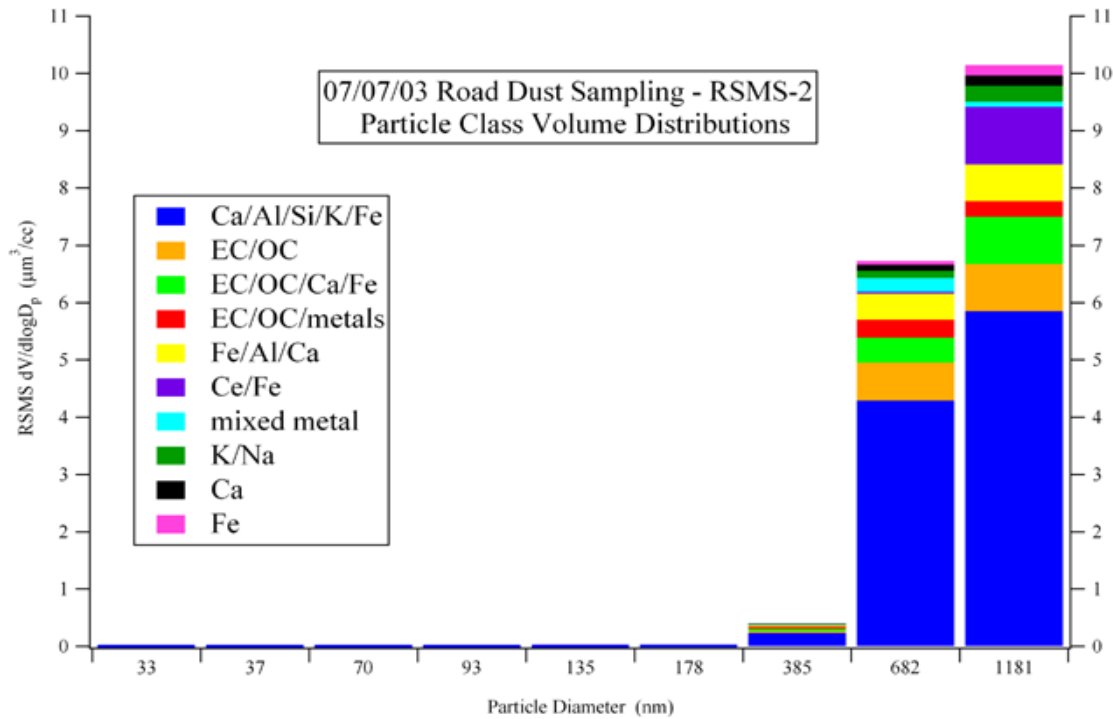

i.

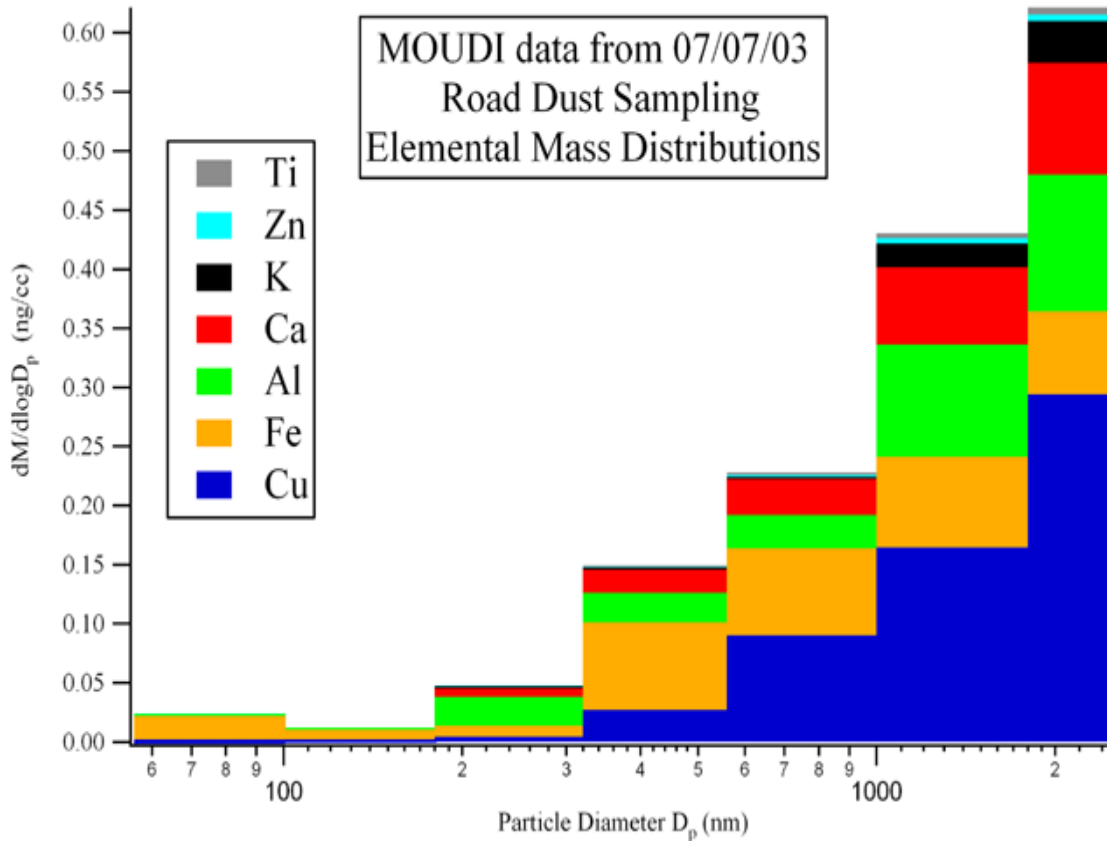

ii.

III. Conclusions

- All three measurement techniques show that the bulk of road dust mass resides within the coarse mode.
- MOUDI and RSMS-2 data agree that, with the exception of copper, iron, calcium, aluminum and potassium are the major constituents of road dust.

Results pt. II - Diesel Exhaust Out

I. Diesel Particle Mass Distributions - SMPS and MOUDI

- Figures i and ii below depict mass distributions for diesel exhaust particles when the engines air intake is from either a clean bag or a road dust bag.

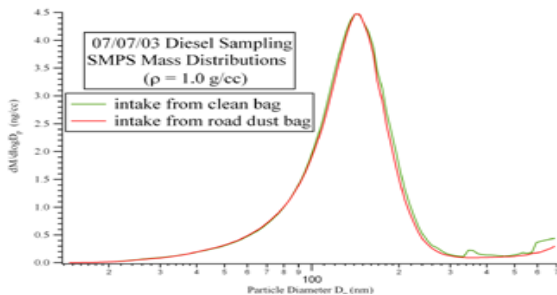

i.

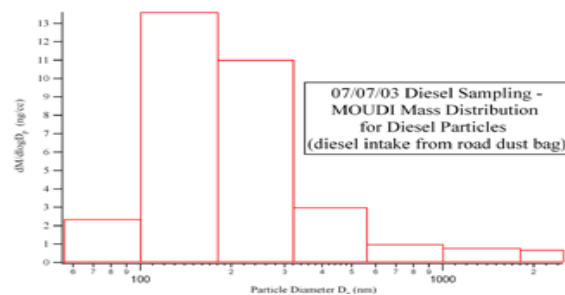

ii.

II. Diesel Particle Composition - RSMS-2 and MOUDI

- RSMS-2 identified two types of particles during diesel exhaust analysis: those containing EC/OC only and those containing EC/OC plus trace metals (Ca/Fe).
 - Figure i below shows the mass distribution of diesel particles containing EC/OC + Ca/Fe for both the case of air intake from a clean bag and air intake from a road dust bag. Also depicted is the fraction of particles detected at each size that contain EC/OC + Ca/Fe.
 - Figure ii depicts the total mass concentration, for both air intake cases, of each metal identified during MOUDI/ICP-MS analysis. In addition, it shows the factor by which each elemental mass concentration has increased due to the presence of road dust.

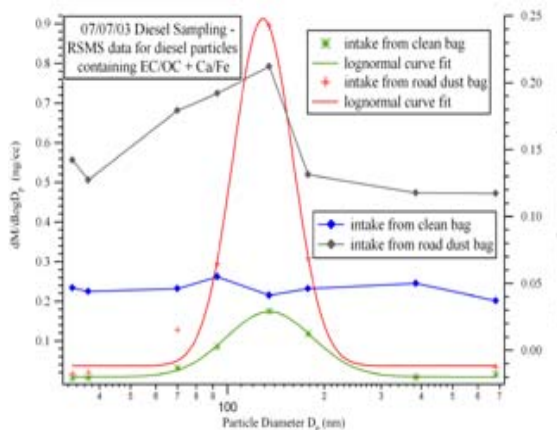

i.

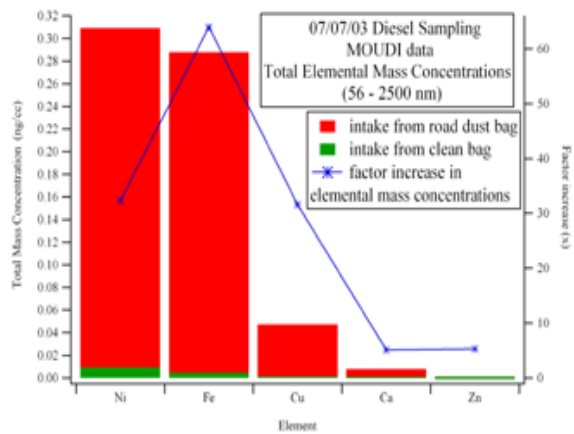

ii.

III. Conclusions

- SMPS and MOUDI measurements show that diesel particle mass, for both air intake cases, is found almost entirely in the fine and ultrafine modes.
- RSMS-2 results indicate significant increases in the fraction, as well as mass distribution, of diesel particles containing EC/OC + Ca/Fe for the case of air intake from a road dust bag versus intake from a clean bag.
- MOUDI/ICP-MS data also shows dramatic increases in the mass concentration of select metals for the case of air intake from a road dust bag versus clean bag.
- Those metals found to increase in both the RSMS-2 and MOUDI results are the same elements that were identified as major constituents of road dust.

Acknowledgements

Department of Energy for funding this research
Natalie Pekney for running ICP-MS analysis on MOUDI filters